

Netz-0-Notstrom Umschalter

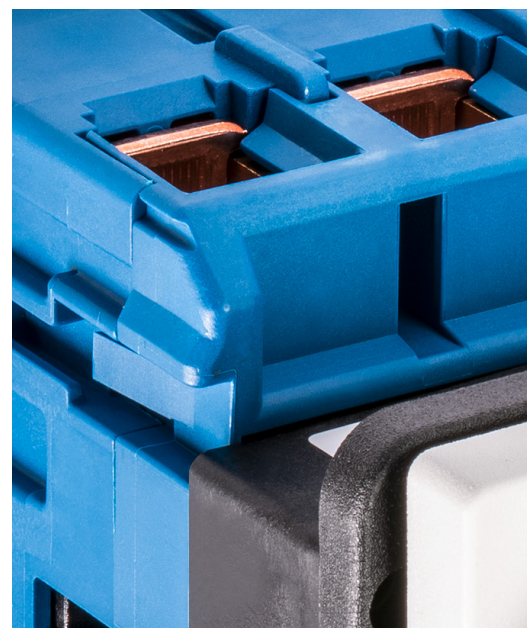
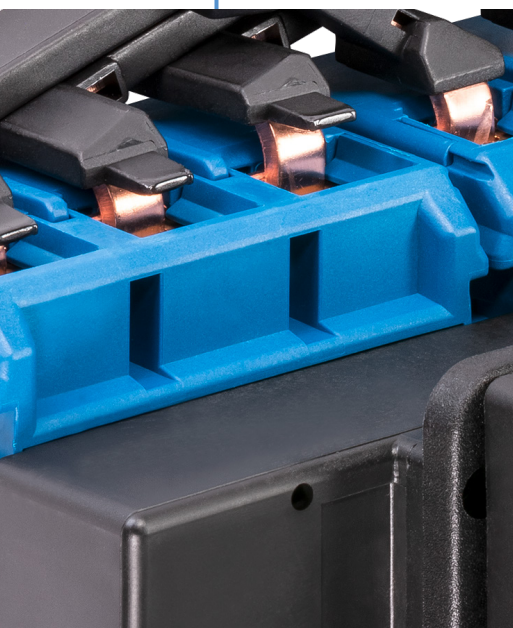

Normgerecht Umschalten mit Kraus & Naimer

Als Teil einer normgerechten Notstromversorgung setzen Sie auf Notstrom-Umschalter von Kraus & Naimer. Diese entsprechen den international gültigen Normen IEC 60947-6-1 und IEC 60947-3 im Bereich der Niederspannungsschaltgeräte.

Notstromversorgung

Zur Einbindung einer Notstromversorgung wird grundsätzlich ein Aggregat benötigt, das mit einem „Notstrom-Umschalter“ oder MTSE (Manual Transfer Switch Equipment) geschaltet wird.

Kommt es zu einer Netzüberlastung, sei es durch Wetterphänomene wie extreme Schneefälle und Sturm oder auch zu hoher Energieanforderung an

das Netz, kann es zu einem Ausfall der Stromversorgung kommen. Hier bietet eine adäquat abgestimmte Notstromversorgung des Eigenheims oder des Betriebes eine zusätzliche Möglichkeit, um den Ausfall für eine gewisse Zeit überbrücken zu können.



Die Norm IEC 60947-6-1 regelt die Ausführung und Prüfungen, die ein Schaltgerät dieser Kategorie erfüllen muss, damit ein Verbraucher auf Strom aus Aggregat-Betrieb sicher und zuverlässig geschaltet werden kann. Hier müssen gewisse technische Parameter eingehalten werden, die auch großteils von der Norm IEC 60947-3 abgedeckt werden und als MTSE (Manual Transfer Switch Equipment) gekennzeichnet sind.

AUSFÜHRUNGEN

Normschiene

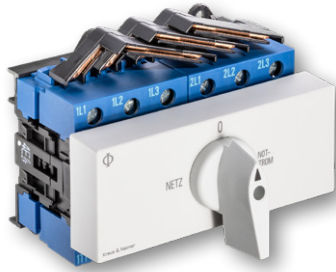
IP20



I_u/I_{th}		Art.-Nr.		Art.-Nr.
	Bezeichnung		Bezeichnung	

3-polig	25 A	KG20A.T903.VE2	70017919	KG20A.T903.VE2.F437	70051999
	32 A	KG32A.T903.VE2	70018147	KG32A.T903.VE2.F437	70019595
	40 A	KA40B.T903.VE2	70038129	KA40B.T903.VE2.F437	70048421
	63 A	KA63B.T903.VE2	70035167	KA63B.T903.VE2.F437	70048423
	80 A	KG80.T903.VE2	70018453	KG80.T903.VE2.F437	70052049
	100 A	KG100.T903.VE2	70017630	KG100.T903.VE2.F437	70052051
	125 A	KG125.T903.VE2	70058233	KG125.T903.VE2.F437	70058234
160 A	KG160.T903.VE2	70032977	KG160.T903.VE2.F437	70058232	

4-polig	25 A	KG20A.T904.VE2	70010222	KG20A.T904.VE2.F437	70051790
	32 A	KG32A.T904.VE2	70018150	KG32A.T904.VE2.F437	70052044
	40 A	KA40B.T904.VE2	70036433	KA40B.T904.VE2.F437	70048425
	63 A	KA63B.T904.VE2	70048395	KA63B.T904.VE2.F437	70048427
	80 A	KG80.T904.VE2	70011630	KG80.T904.VE2.F437	70051967
	100 A	KG100.T904.VE2	70011037	KG100.T904.VE2.F437	70052041
	125 A	KG125.T904.VE2	70017720	KG125.T904.VE2.F437	70024912
160 A	KG160.T904.VE2	70032016	KG160.T904.VE2.F437	70058231	

Fronteinbau

IP66/67

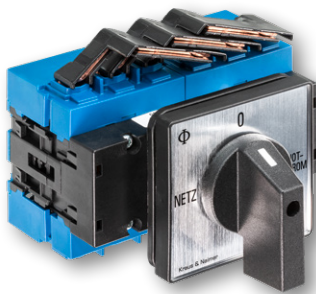

I_u/I_{th}		Art.-Nr.		Art.-Nr.
	Bezeichnung		Bezeichnung	

3-polig	25 A	KG20A.T903.E	70017917	KG20A.T903.E.F437	70051992
		KG20B.T903.E	70017977	KG20B.T903.E.F437	70058235
	32 A	KG32A.T903.E	70018145	KG32A.T903.E.F43	70051998
		KG32B.T903.E	70018201	KG32B.T903.E.F437	70058237
	40 A	KA40B.T903.E	70034217	KA40B.T903.E.F437	70048404
	63 A	KA63B.T903.E	70035184	KA63B.T903.E.F437	70048406
	80 A	KG80.T903.E	70018451	KG80.T903.E.F437	70052057
100 A	KG100.T903.E	70017628	KG100.T903.E.F437	70051788	
125 A	KG125.T903.E	70017716	KG125.T903.E.F437	70058239	
160 A	KG160.T903.E	70017780	KG160.T903.E.F437	70058240	

4-polig	25 A	KG20A.T904.E	70034713	KG20A.T904.E.F437	70051972
		KG20B.T904.E	70011142	KG20B.T904.E.F437	70023814
	32 A	KG32A.T904.E	70018148	KG32A.T904.E.F437	70052054
		KG32B.T904.E	70018203	KG32B.T904.E.F437	70034062
	40 A	KA40B.T904.E	70036427	KA40B.T904.E.F437	70048408
	63 A	KA63B.T904.E	70048392	KA63B.T904.E.F437	70048410
	80 A	KG80.T904.E	70018454	KG80.T904.E.F437	70051870
100 A	KG100.T904.E	70017631	KG100.T904.E.F437	70052063	
125 A	KG125.T904.E	70017718	KG125.T904.E.F437	70029970	
160 A	KG160.T904.E	70017782	KG160.T904.E.F437	70024146	

Maße in mm

3-polig

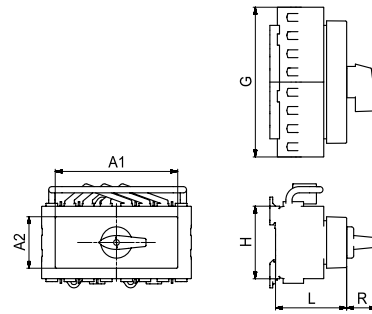
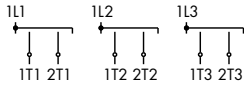

4-polig

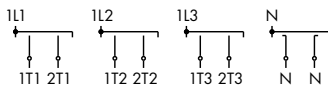

Schaltertype	A1	A2	G 3p	G 4p	H	L	R
KG20A, KG32A	43,7	45,4	84	111	54	64	26
KA40B, KA63B	52,4	45,5	100	132	64	68,6	26
KG80, KG100	70	45	140	184	80	76,2	34
KG125, KG160	112	45	224	300	108	101,5	43

3-polig

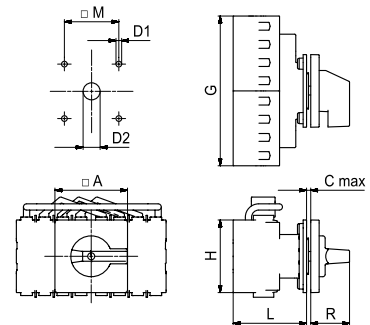
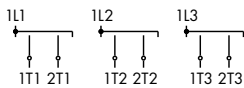

4-polig

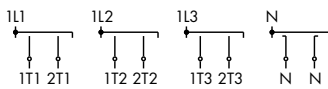

Schaltertype	A	C max	G 3p	G 4p	L	H	R	M	D1	D2
KG20A, KG32A	48	4	84	111	61,3	54	29,1	36	5	10
KG20B, KG32B	64	4	84	111	61,3	54	29,1	36	5	10
KA40B, KA63B	64	4	100	132	64,7	64	34,2	48	5	10
KG80, KG100	64	4	140	184	81,8	80	34,2	48	5	10
KG125, KG160	88	5,5	224	300	98	108	43,4	68	6	13

AUSFÜHRUNGEN

Verteilereinbau mit Achsverlängerung ohne Türkupplung¹

IP40

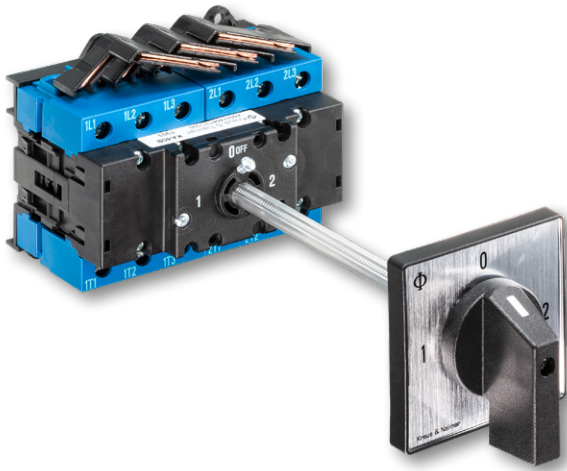

I_n/I_{th}	Bezeichnung	Art.-Nr.	Bezeichnung	Art.-Nr.
--------------	-------------	----------	-------------	----------

3-polig	25 A	KG20B.T903/57.VE	70034684	KG20B.T903/D-A066.VE	70034694
	32 A	KG32B.T903/57.VE	70034685	KG32B.T903/D-A025.VE	70034695
	40 A	KA40B.T903/57.VE	70035154	KA40B.T903.VE.DE21	70057909
	63 A	KA63B.T903/57.VE	70035122	KA63B.T903.VE.DE21	70057910
	80 A	KG80.T903/57.VE	70034686	KG80.T903/D-W009.VE	70034698
	100 A	KG100.T903/57.VE	70034687	KG100.T903/D-A062.VE	70034699
	125 A	KG105.T903/57.VE	70034688	KG105.T903/D-A005.VE	70034700
160 A	KG160.T903/57.VE	70034689	KG160.T903/D-A058.VE	70034701	

4-polig	25 A	KG20B.T904/57.VE	70034690	KG20B.T904/D-A040.VE	70034702
	32 A	KG32B.T904/57.VE	70034691	KG32B.T904/D-A083.VE	70034703
	40 A	KA40B.T904/57.VE	70056189	KA40B.T904.VE.DE21	70057903
	63 A	KA63B.T904/57.VE	70056190	KA63B.T904.VE.DE23	70057905
	80 A	KG80.T904/57.VE	70027274	KG80.T904/D-A077.VE	70034706
	100 A	KG100.T904/57.VE	70034692	KG100.T904/D-A101.VE	70034707
	125 A	KG105.T904/57.VE	70034693	KG105.T904/D-A011.VE	70034708
160 A	KG160.T904/57.VE	70022113	KG160.T904/D-A096.VE	70034709	

Aufputz³

IP66/67



I_n/I_{th}	Bezeichnung	Art.-Nr.	Bezeichnung	Art.-Nr.
--------------	-------------	----------	-------------	----------

3-polig	25 A	KG20B.T903.KL10	70034730	KG20B.T903.KL10.F437	70052040
	32 A	KG32B.T903.KL10	70034731	KG32B.T903.KL10.F437	70051965
	40 A	KA40B.T903.KL70	70048397	KA40B.T903.KL70.F437	70048429
	63 A	KA63B.T903.KL70	70048399	KA63B.T903.KL70.F437	70048431

4-polig	25 A	KG20B.T904.KL10	70034733	KG20B.T904.KL10.F437	70051982
	32 A	KG32B.T904.KL10	70034734	KG32B.T904.KL10.F437	70051994
	40 A	KA40B.T904.KL70	70048401	KA40B.T904.KL70.F437	70048433
	63 A	KA63B.T904.KL70	70024774	KA63B.T904.KL70.F437	70048435

3-polig

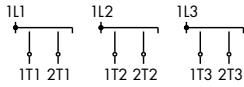

4-polig

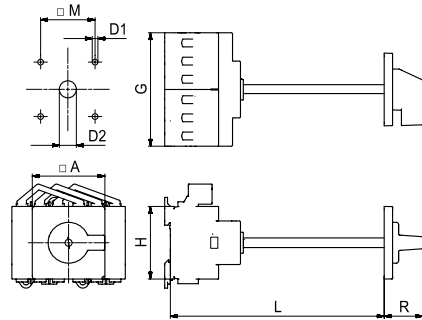
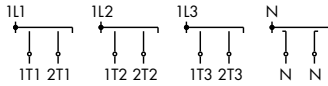

Bodenplatte
3-polig
KG20B-KG100
KA40B-KA63B

4-polig
KG20B-KG100

4-polig
KG125-KG160

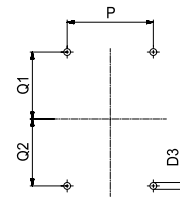
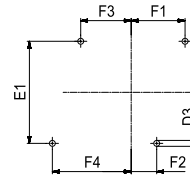
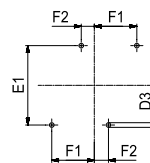

Schaltertype	A	G	L	H	R	M	D1	D2	D3	E1	F1	F2	F3	F4	P	Q1	Q2
KG20B, KG32B	64	111	190	54	29,1	48	5	10-15	4,1	60	32	10	23,5	45,5	-	-	-
KA40B	64	100	180	64	34,2	48	5	10-15	4,1	70	37,5	12,5	28,5	53,5	-	-	-
KA63B	64	100	195	64	34,2	48	5	10-15	4,1	70	37,5	12,5	28,5	53,5	-	-	-
KG80	64	184	380	80	34,2	48	5	10-15	5,2	90	47,5	22,5	44,5	69,5	-	-	-
KG100	64	184	450	80	34,2	48	5	10-15	5,2	90	47,5	22,5	44,5	69,5	-	-	-
KG125, KG160 ²	88	300	450	108	43,4	68	6	13-17	6	-	-	-	-	76	59-61	59-61	-

¹ Achse wird direkt durch den Gehäusedeckel geführt. Auf Wunsch Türkupplung als Zusatzeinrichtung möglich, wir empfehlen M700 (Siehe Hauptkatalog Seite 79).

² nicht für Normschiene

3-polig

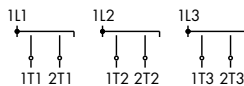

4-polig

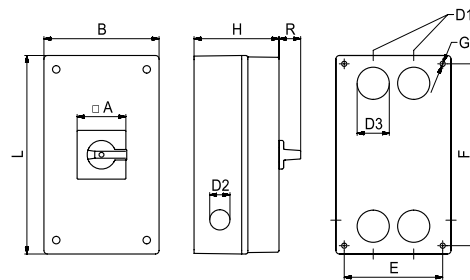
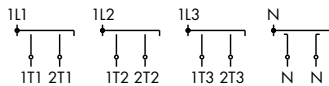

Schaltertype	Bauform	A	B	H	D1	D2	D3	E	F	G	R
KG20B, KG32B	KL10	62	145	107	M25/40	M25	M40	124	229	6,5	28
KA40B, KA63B	KL70	64	145	107	M25/40	M25	M40	124	229	6,5	27

³ Gehäuse ohne Deckelverriegelung



 Kraus & Naimer

www.krausnaimer.com

© Kraus & Naimer, Februar 2023